

Sluiten - Closing - Schliessen

C2

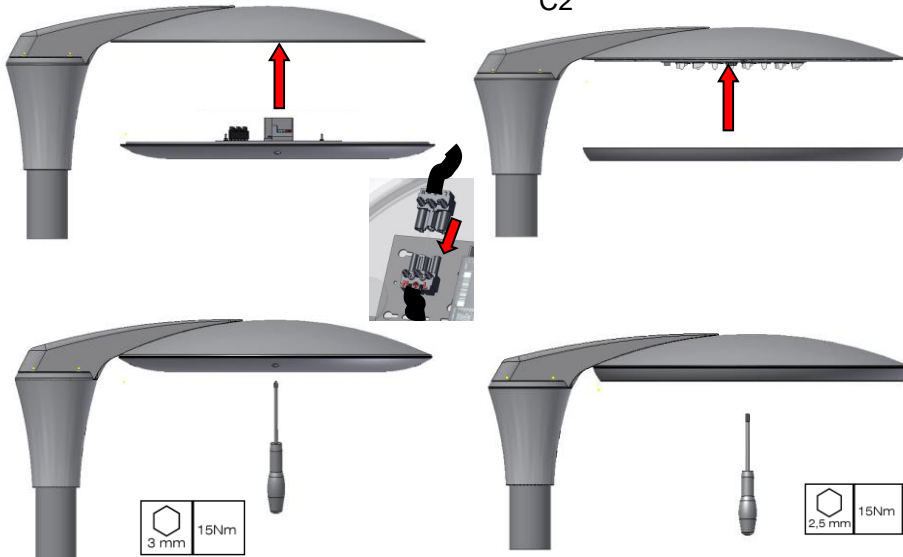

Locatie Zhaga connector – Location Zhaga connector – Standort Zhaga connector



OF - OR

LET OP: dit is een bajonetsluiting dus niet hard doordraaien!

ATTENTION: this is a bayonet fastener so do not turn hard!

ACHTUNG: Dies ist ein Bajonettverschluss, also nicht hart drehen!

Disclaimer

**NL-** Alle informatie, ontwerp en specificaties die in deze handleiding zijn opgenomen waren ten tijde van publicatie correct. Echter, omdat het product continu in verbetering is, kan het uiteindelijke product enigszins afwijken van de functionaliteit die in deze handleiding is vermeld.

**EN-** All information, design and specifications in this manual, were correct when published. Yet: because this product is constantly being improved, the final product can be slightly different to the functionality that is represented in this manual.

**DE-** Alle Informationen, Design und Spezifikationen in dieser Anleitung waren korrekt zur Zeit Publikation. Dennoch: weil dieses Produkt konstant verbessert wird, kann das endliche Produkt etwas anders sein als in dieser Anleitung dargestellt ist.



LIGHTRONICS B.V.

Spuiweg 19  
5145 NE Waalwijk, NL  
Postbus 150  
5140 AD Waalwijk, NL

Tel: +31(0)416 568 600  
Fax: +31(0)416 568 601  
E-mail: info@lightronics.nl  
www.lightronics.nl

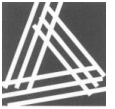

Revisie 2 – 03-12-2018

PRUNUS C  
Montagehandleiding - Installation instructions - Montageanleitung

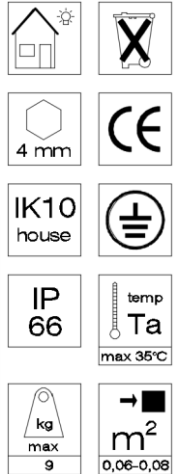

Hoofdafmetingen (mm) - Main dimensions (mm) - Hauptabmessungen (mm)

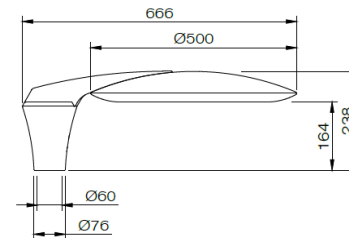

PRUNUS C1

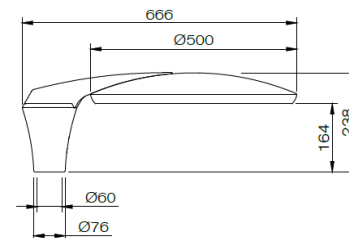

PRUNUS C2

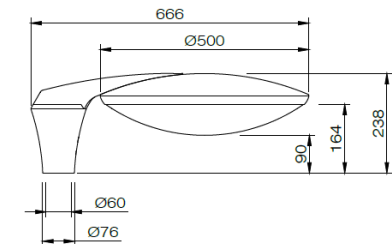

PRUNUS C3

Montage op mast Ø60 of Ø76- Mounting on pole Ø60 or Ø76 - Montage auf Mast Ø60 oder Ø76



Aansluiten bekabeling - Installing wiring - Anschliessen Leitung

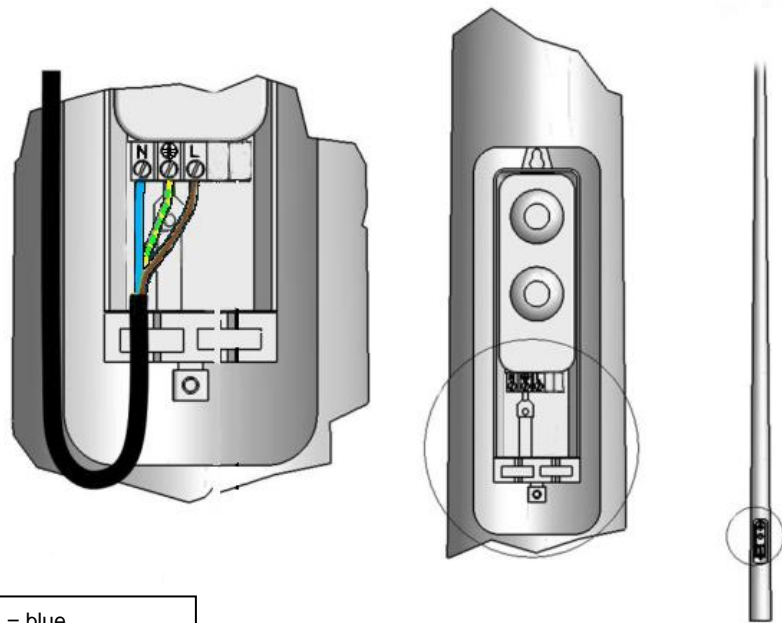

Openen armatuur - Opening luminaire - Öffnen Leuchte

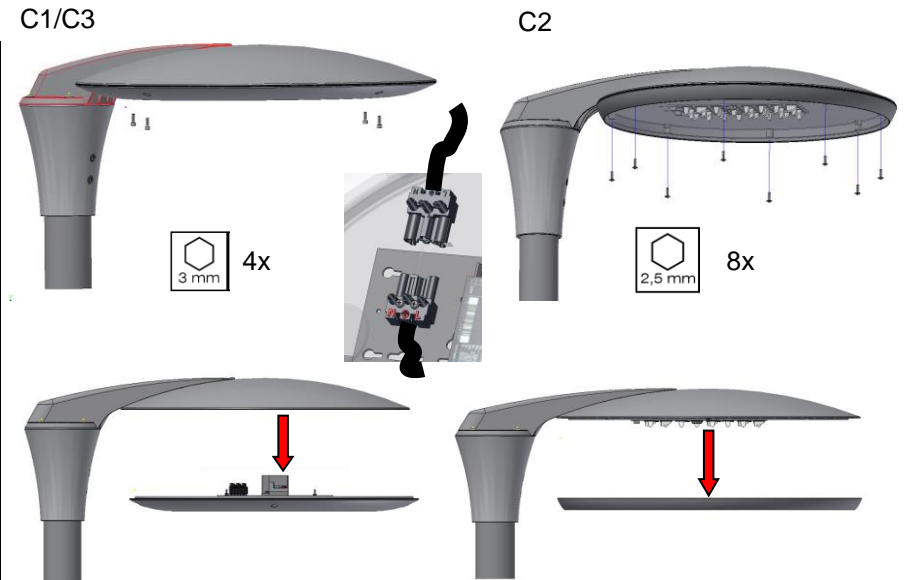

Unitplaatwissel - Unitplate replacement - Unitplatte Wechsel

