

WAND EN PLAFONDVERLICHTING - HOGRO PLUS

Slagvast opbouw design-armatuur

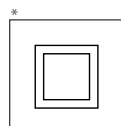
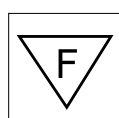
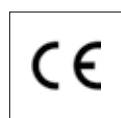
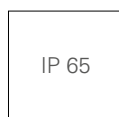
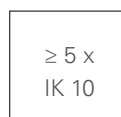

* option

DOTT XL

Toepassingsgebieden

- corridors
- entree buitenzijde
- entreehallen
- lifthallen
- trappenhuizen

Behuizing: aluminium gecoat (DB703) of RAL 9010

Lichtbron: LED

Classificatie: IP 65

Slagvastheid: ≥ 5 x IK 10

Afmetingen in mm:

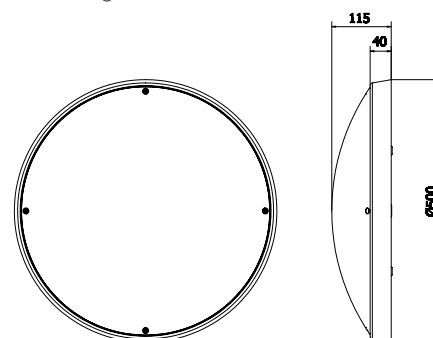

WAND EN PLAFONDVERLICHTING - HOGRO PLUS

Technische specificaties



LICHTBRON LED	LUMEN OUTPUT (LM) *	VERWACHTE LEVENSDUUR HR **
LED	1600	100.000
LED	2280	100.000
LED	3050	100.000

* Voor een actueel lumen-vermogen overzicht kijkt u op: www.lightronics.nl

** L70 / F10

Productspecificaties

- kabelinvoer: middenachter
- kleurtemperatuur neutraal wit (4000K)
- levensduur LED (driver + LED) 100.000 uur bij T-omgeving = 25° C (L70/F10)
- lichtkap: UV-gestabiliseerd polycarbonaat opaal of frosted
- maatvoering (dxh): 500 x 115 mm
- montage-, installatie- en onderhoudsvriendelijk
- RA-waarde: > 80
- spanning: 230/240 V, 50 Hz
- voorzien van speciale coating t.b.v. kustgebieden

Opties

- andere RAL-kleur
- dimbaar 1-10 V
- kleurtemperatuur warm wit (3000K)
- losse kap opaal
- nood/continuverlichting, incl. ATF (1 uur)
- veiligheidsklasse II

DOTT XL Opaal LED

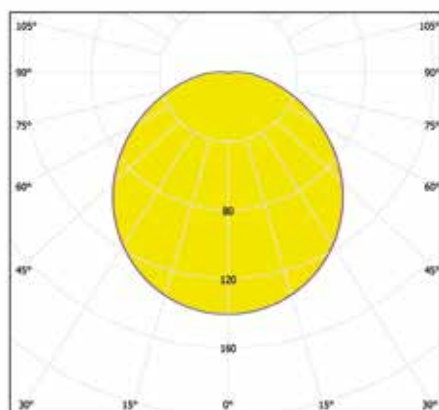

Bezoek onze website voor de meest actuele informatie:

www.lightronics.nl

